

MODEL GRZ

RECTANGULAR, 2-HOUR FIRE RATED,
ZERO-CLEARANCE GREASE DUCT

U.S. PATENT NO. D908,201

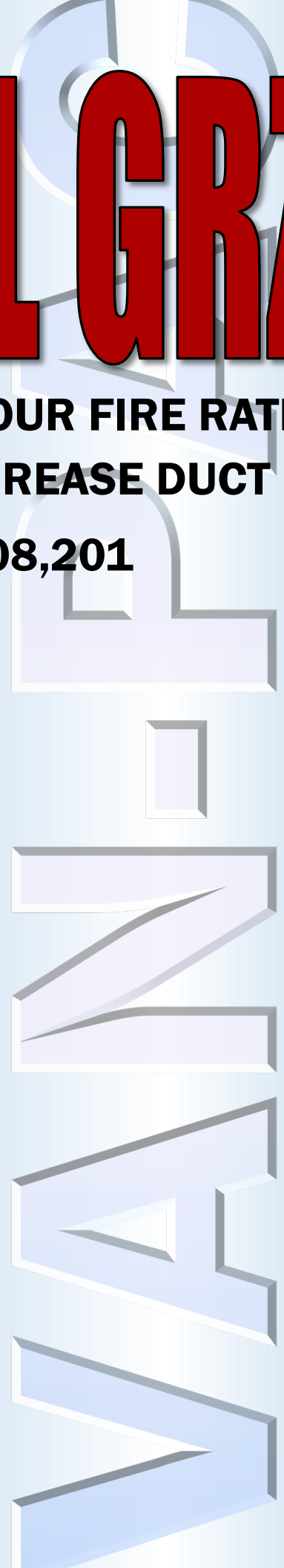

For over 75 years, Van-Packer has supplied venting products to the Commercial and Industrial heating and process markets. For the past 30 years, we have also provided round, listed and labeled factory built grease duct to the commercial kitchen ventilation market. Now, we are pleased to add Model GRZ, rectangular, fire-rated, zero clearance factory built grease duct to our Commercial Kitchen product offering.

Model GRZ Grease Duct can be intermixed with our other grease duct products to maximize versatility and minimize costs while still offering the safest kitchen ventilation system you can get.

LISTINGS

Model GRZ grease ducts are “listed” by Intertek file VPC/FMF 120-03 (USA) and VPC/FMF 120-04 (Canada), as “*Prefabricated Grease Duct*” in accordance with UL1978/ULC S662 (*Standard for Safety, Grease Ducts*) and with UL 2221/ULC S144 (*Tests for Fire Resistive Grease Duct Enclosure Assemblies*) when installed in accordance with Van-Packer’s installation instructions and applicable local or national codes.

Model GRZ is classified for a maximum 2-hour fire resistance rating and may be installed at zero clearance to combustibles, except within a completely enclosed nonventilated combustible enclosure. This rating qualifies the insulation and outer shell wall as an alternative to a fire resistive shaft enclosure. Thus, Model GRZ grease duct can pass from one fire rated space to another without the need to construct another fire rated enclosure.

PROFESSIONAL ENGINEERING AND TECHNICAL SUPPORT

Van-Packer welcomes the opportunity to assist you with your design. Our staff can provide you with duct sizing and pressure drop analysis, custom project specifications and system drawings. We offer technical support both before and after the sale. Our installation drawings provided with the project materials include a parts list keyed to the drawing. This is to make it easy for installers to assure that critical parts are installed in their proper locations.

VERSATILITY

Van-Packer grease duct products offer unsurpassed versatility. We offer our rectangular grease duct in width to height ratios of up to 6:1 with the ability to mix round or rectangular grease duct parts in a system. This allows the grease duct to be installed with a minimal headroom requirement while still taking advantage of the low pressure drop and high flow rates allowable with round grease duct.

For installation details, please see “*Model GRZ Zero Clearance Grease Duct Installation Guidelines.*”

MATERIALS

Liner (Inner Wall):

2 Hour Fire Rated Duct – Liner is constructed of 20 GA (0.035”) Type 304 stainless steel

Shell (Outer Wall):

Shell for duct with all outer dimensions 36” or less – 24 GA (0.024”) aluminized steel or Type 430 stainless steel.

Shell for duct with any outer dimension over 36” – 20 GA (0.035”) aluminized steel or Type 430 stainless steel.

SPECIAL FITTINGS

Model GRZ Grease Duct fittings include clean out access doors, nozzle sections (for washdown or fire suppression), drain sections, tees, elbows, and adapters for fans and hoods. Special fittings for sloped sections are available, please consult factory.

SIZES

Model GRZ Grease Duct is available in either square or rectangular configurations. The maximum allowable width to height ratio is 6 to 1, for instance 6” x 36”.

Square duct is available in sizes from 6” x 6” to 36” x 36”. Rectangular duct is available in sizes from 6” x 8” to 27” x 48”. The chart on page 3 shows the weight and capacity of common duct sizes. Any combination of width and height from 6” to 48” is available provided the net inside area does not exceed 1296 square inches.

CAPACITY AND WEIGHT (Common Sizes)

Approx. CFM	Size (inch)		Weight LB/FT
	Width	Height	
700	6	10	22
900	8	10	24
1100	10	10	26
1300	12	10	28
1600	14	10	30
1800	16	10	32
2000	18	10	34
2200	20	10	36
2400	22	10	38
2700	24	10	40
2900	26	10	42
3100	28	10	44
3300	30	10	46
3600	32	10	52

Approx. CFM	Size (inch)		Weight LB/FT
	Width	Height	
3800	34	10	54
4000	36	10	56
4200	38	10	59
4400	40	10	61
4700	30	14	52
5000	32	14	56
5300	34	14	59
5600	36	14	61
5900	38	14	63
6200	40	14	65
6400	36	16	63
6800	38	16	65
7100	40	16	67
7500	42	16	69

Approx. CFM	Size (inch)		Weight LB/FT
	Width	Height	
7600	38	18	67
8000	40	18	69
8400	42	18	71
8900	40	20	71
9300	42	20	73
9800	44	20	76
10300	42	22	76
10800	44	22	78
11200	46	22	80
11700	48	22	82
12300	46	24	82
12800	48	24	84
13300	46	26	84
14400	48	27	87

Capacity (CFM) is approximate, based on a velocity of 1600 Ft/Min.

Additional sizes not shown above are available. Size range from 6" x 6" to 48" x 27" Contact factory for additional information

Weights are approximate assembled pounds per linear foot.

PART IDENTIFICATION

Part numbers have the model designator "GRZ" as a prefix, followed by the duct size (width X height), the part description code, special qualifier code, a liner material code and a shell material code.

Examples of part numbers with their associated description and part number breakdown are shown below:

GRZ22X14STR42AL

Refers to a Model GRZ 22" x 14" straight section, 42 inches long, constructed with a 304 SS liner and an aluminized steel shell.

GRZ = Model GRZ Product Code
 22X14 = Section Size (liner width x height)
 STR = Part Code (Straight Section)
 42 = Qualifier Code (42" Long)
 A = Liner Material Code (Type 304 SS)
 L = Shell Material Code (Aluminized Steel)

GRZ44X2690T40X18AC

Refers to a Model GRZ 44" x 26" (body size) 90° Tee with a 40" x 18" projection, constructed with a 304 SS liner and a 430 SS Shell.

GRZ = Model GRZ Product Code
 44X26 = Tee Body Size (liner width x height)
 90T = Part Code (90° Tee Section)
 40X18 = Qualifier Code (Tee Projection Size)
 A = Liner Material Code (Type 304 SS)
 C = Shell Material Code (Type 430 SS)

LINER MATERIAL CODES

A = Type 304 Stainless Steel

SHELL MATERIAL CODES

C = Type 430 Stainless Steel
 L = Aluminized Steel

Additional information about parts availability and materials is available. Please contact our Tech Services Department by email—vpotech@vpstack.com or by phone **888-VPSTACK** (888-877-8225) or on our web site www.vpstack.com.

SUPPORT LIMITS

Horizontal Installation -

Model GRZ Grease Duct is designed to be supported in horizontal installations by means of a trapeze style support using either 2" x 2" x 3/16" steel angle or P1000 steel Unistrut® for the horizontal members of the trapeze. The horizontal member is suspended using 1/2" or larger threaded rod attached to the ceiling or structural members with through holes and appropriately sized nuts and washers. This support method is capable of supporting up to 500 Lbs. of GRZ Grease Duct per trapeze.

An alternative method uses factory supplied Hanger Bands (BHB) in lieu of the steel angles or Unistrut®. This support method is capable of supporting up to 420 Lbs. of GRZ Grease Duct per trapeze.

The maximum spacing of horizontal supports is 12 feet. Note that a shorter distance between supports may be required if the duct weight exceeds the support weight limits above.

Vertical Installation -

In vertical installations, Model GRZ Grease Duct must be supported by means of a plate support assembly (PLS), which is attached to noncombustible building structure. The maximum loading of a plate support assembly is 2,400 lbs.

If the grease duct is adjacent to an interior or exterior wall, the plate support assembly can be attached to the building structure using GRZ Wall Brackets (WBR). The wall brackets must be spaced so the weight supported by each set of brackets does not exceed the following limits:

Brackets sizes ≤32" - Max. 1300 lbs.

Brackets sizes > 32" - Max. 900 lbs.

For long vertical runs of duct, lateral guides must be spaced at a maximum of 30 Feet. A Full Angle Support (FAS) attached to the building structure is used to provide lateral support.

PRODUCT WEIGHT

Model GRZ weights are shown on pages 8 to 10 of this brochure. Use these weights to calculate the lengths of runs that can be supported in accordance with the information given above.

SLOPE

In accordance with NFPA 96, the IMC, and the UMC, Model GRZ Grease Duct must be sloped toward the hood to prevent grease from pooling on the bottom of the duct. The required slope is 1/8 inch in 12 inches (min) slope on horizontal runs up to 75 ft and 1/2 inch in 12 inches (min) slope on horizontal runs greater than 75 ft.

Van-Packer can provide special fittings to accommodate these slope requirements where a horizontal run meets a vertical run or where long horizontal runs require a "sawtooth" approach to minimize overhead clearance requirements.

RECTANGULAR DOUBLE WALL DUCT - GRZ__X__STR__

Available as square duct from 6" X 6" to 36" X 36" inside or as rectangular duct from 6" X 8" to 48" X 27" inside. Outside dimensions equal inside dimensions plus 6".

Standard lengths are 18", 30" or 42" and special lengths are available on request. Please consult factory for availability of special lengths.



ACCESS PANEL SECTION - GRZ__X__APS__

Used to provide access for cleanout. Access panels are available in the following sizes:

4" X 8", 8" X 8", 8" X 14", 14" X 14" and 20" X 20"

The largest panel that will fit the duct should be selected. There must be at least 1" from the bottom of the duct to the bottom of the opening.



DUCT DRAIN SECTION - GRZ__X__DDS__

The Duct Drain Section is used to drain grease from a horizontal duct run. An internal dam directs grease to the drain coupling. See notes 1 & 2 below.



DUCT COUPLING SECTION - GRZ__X__DCS__

The Duct Coupling Section is used to allow installation of fire suppression nozzles, fire detection devices, wash down nozzles or to drain condensate or grease from a horizontal section where a grease dam is not required. Specify coupling location on duct. See notes 1 & 2 below.



Notes apply to both Duct Drain Section and Duct Coupling Section

1. The drain is usually installed in an 18" duct length, but may be installed in other duct lengths if required. Consult factory for availability.
2. Drain nipple or coupling is always on the first side of the size number, i.e., on the photo to the right, the duct size is 6 x 12. The duct drain is in the 6" side.

ELBOWS - GRZ__X____E__

Elbows are used to change direction, for offsets and as peaks and valleys where long horizontals runs require a "sawtooth" configuration. Elbows are available from 5° to 90° turns. Standard configurations are 5°, 15°, 30°, 45° and 90°.

For other turns, standard elbows may be combined or special elbows can be ordered. Consult factory for availability.



90° CENTERED TEE, GRZ__X__90T__X____

The 90° Centered Tee is used for 90° turns, manifolds and cleanouts. Available with reduced size projection. Specify projection size (width and height).



45° TEE, GRZ__X__45T__X____

The 45° Tee is used for low resistance 45° direction changes. Available with reduced size projection. Specify projection size (width and height).

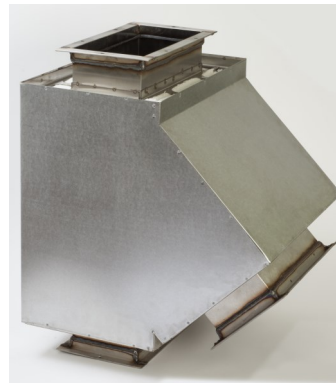

90° WYE SECTION, GRZ__X__WYE__

The 90° Wye Section is used for 90° turn with cleanout access or for joining 2 systems. All connections are the same size.

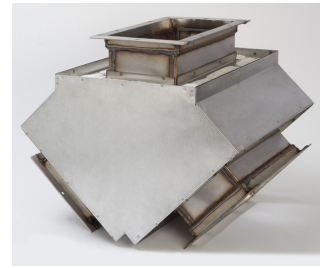

END CAP WITH DRAIN, GRZ__X__C/D__

Used as a drain at the bottom of a vertical section.

END CAP, GRZ__x__CAP__

Same as above, but bottom is solid with no drain (not pictured).



FAN ADAPTER PLATE, GRZ__X__FAP**X**__

The Fan Adapter Section is used with a curb and hinged, up-blast type exhaust fan. The plate dimensions must be customer specified to fit the curb.

Note: **X** is the plate size, which must equal the outside dimensions of the fan curb's rails



PLATE SUPPORT ASSEMBLY, GRZ__x__PLS__

The PLS consists of a support plate and four half draw bands. The support plate is sandwiched between the flanges of adjacent grease duct sections and is supported by field fabricated support members. Refer to Model GRZ Installation Guidelines for support limitations.

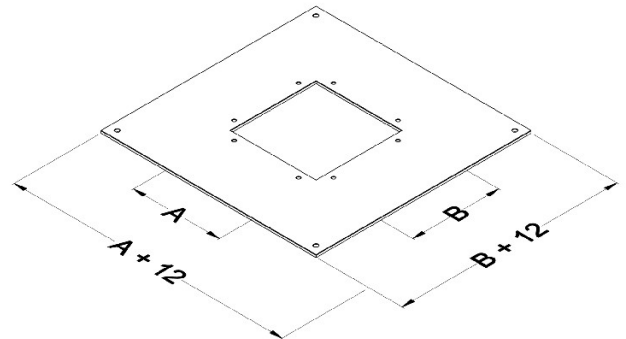

FULL ANGLE SUPPORT, GRZ__x__FAS__

Full angle supports, in conjunction with field fabricated support members attached to the building or structure, are intended to laterally brace the vertical assembled duct lengths from side loads and to also maintain alignment as the duct expands and contracts. The FAS is comprised of (2) halves and when bolted together provides a slight clearance fit to the duct.

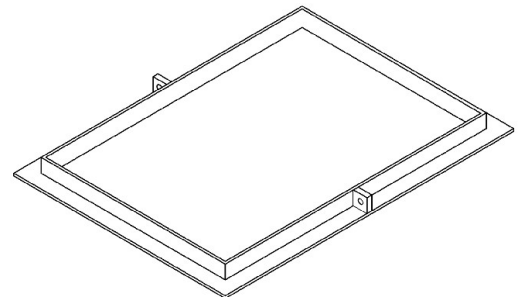

WALL BRACKET, GRZ__WBR__

Wall brackets are used in conjunction with our vertical or horizontal structural and lateral supports. The WBR, in conjunction with anchor bolts or in some instances, additional field fabricated support members attached to the building or structure, is intended to provide a rigid (static) support location. The WBR is comprised of (2) wall brackets (left and right). The size of the WBR is determined by the size of the duct side that is perpendicular to the wall. Refer to Model GRZ Installation Guidelines for support limitations.

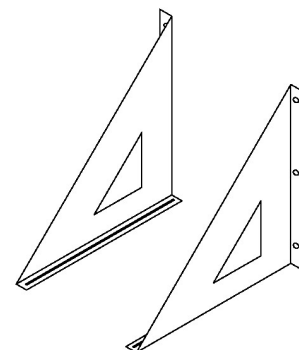

FINISHING PLATE, GRZ__X__FPL__

The Finishing Plate is used when the duct penetrates an interior floor, ceiling or wall where a fire rating is not required..

Note: Illustration shows FPL on top and bottom of the penetration. Two FPLs are required for this installation.

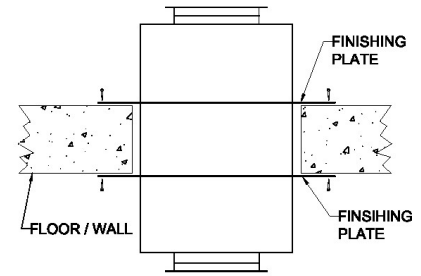

FLOOR PENETRATION ASSEMBLY, GRZ__X__FPA__

This penetration assembly must be used when the duct passes through a fire resistant floor or ceiling. The FPA includes (1) insulated penetration plate w/ collar, (1) uninsulated penetration plate w/ collar, and insulation roll, strips, or loose fill.

WALL PENETRATION ASSEMBLY, GRZ__X__WPA__

This penetration assembly must be used when the duct passes through an interior fire resistant wall. The WPA is comprised of (2) insulated penetration plates w/ collar, cover plates and insulation roll, strips, or loose fill.

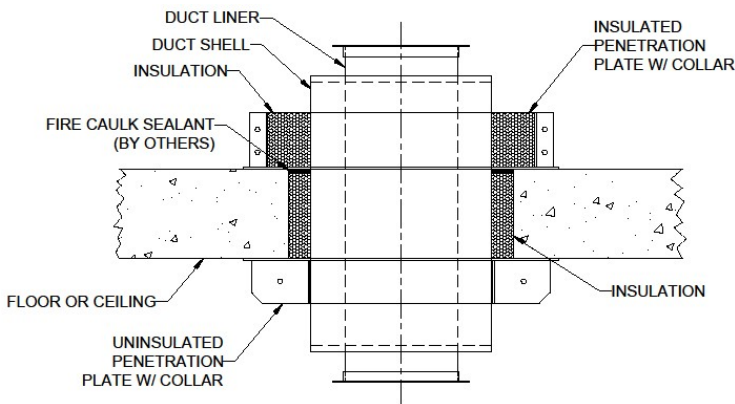

FLOOR PENETRATION ASSEMBLY

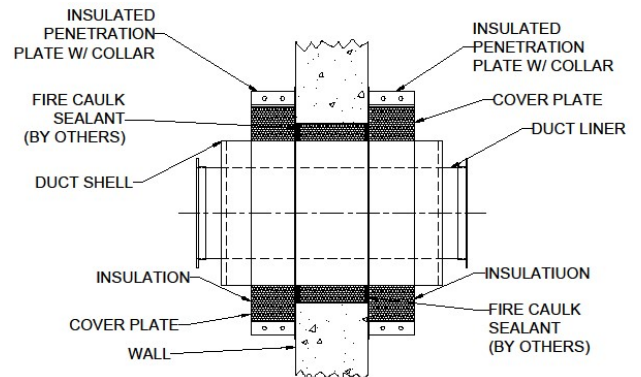

WALL PENETRATION ASSEMBLY

FLASHING, GRZ__X__FLS__

Used when the grease duct is penetrating a non-combustible roof structure without a fan curb, such as with a utility set fan. The flashing is constructed of 24-gauge aluminized steel. Stainless steel option is available.

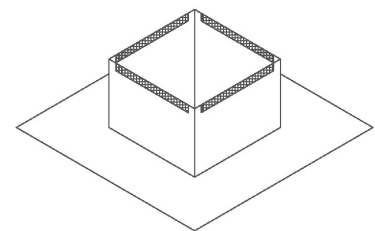

COUNTER FLASHING, GRZ__X__CFL__

A counter flashing is installed above the flashing to provide rain protection. Sealant should be applied to prevent leakage. The counter flashing is constructed of 24-gauge aluminized steel. Stainless steel option is available.

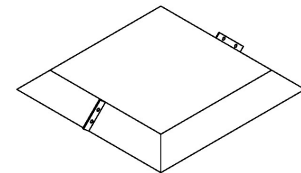

GUY ATTACHMENT PLATE, GRZ__X__GAP__

Guy attachment plate is used in conjunction with wires, tensioners, anchors, and other miscellaneous hardware attached to building or structure. It is intended to laterally brace vertical assembled duct lengths from wind loads and to maintain alignment as the duct expands and contracts.

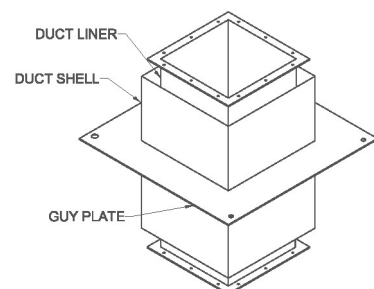

MODEL GRZ Weight Chart

H = Height of Section
W = Width of Section

Wt = Weight in Pounds per Linear Foot
 = Size not available

H	W	Wt
6	6	18
6	8	20
6	10	22
6	12	24
6	14	26
6	16	28
6	18	30
6	20	32
6	22	34
6	24	36
6	26	38
6	28	40
6	30	42
6	32	48
6	34	50
6	36	52

H	W	Wt
8	6	20
8	8	22
8	10	24
8	12	26
8	14	28
8	16	30
8	18	32
8	20	34
8	22	36
8	24	38
8	26	40
8	28	42
8	30	44
8	32	50
8	34	52
8	36	54
8	38	56
8	40	59
8	42	61
8	44	63
8	46	65
8	48	67

H	W	Wt
10	6	22
10	8	24
10	10	26
10	12	28
10	14	30
10	16	32
10	18	34
10	20	36
10	22	38
10	24	40
10	26	42
10	28	44
10	30	46
10	32	52
10	34	54
10	36	56
10	38	59
10	40	61
10	42	63
10	44	65
10	46	67
10	48	69

H	W	Wt
12	6	24
12	8	26
12	10	28
12	12	30
12	14	32
12	16	34
12	18	36
12	20	38
12	22	40
12	24	42
12	26	44
12	28	46
12	30	48
12	32	54
12	34	56
12	36	59
12	38	61
12	40	63
12	42	65
12	44	67
12	46	69
12	48	71

H	W	Wt
14	6	26
14	8	28
14	10	30
14	12	32
14	14	34
14	16	36
14	18	38
14	20	40
14	22	42
14	24	44
14	26	46
14	28	48
14	30	50
14	32	56
14	34	59
14	36	61
14	38	63
14	40	65
14	42	67
14	44	69
14	46	71
14	48	73

H	W	Wt
16	6	28
16	8	30
16	10	32
16	12	34
16	14	36
16	16	38
16	18	40
16	20	42
16	22	44
16	24	46
16	26	48
16	28	50
16	30	52
16	32	59
16	34	61
16	36	63
16	38	65
16	40	67
16	42	69
16	44	71
16	46	73
16	48	76

H	W	Wt
18	6	30
18	8	32
18	10	34
18	12	36
18	14	38
18	16	40
18	18	42
18	20	44
18	22	46
18	24	48
18	26	50
18	28	52
18	30	54
18	32	61
18	34	63
18	36	65
18	38	67
18	40	69
18	42	71
18	44	73
18	46	76
18	48	78

H	W	Wt
20	6	32
20	8	34
20	10	36
20	12	38
20	14	40
20	16	42
20	18	44
20	20	46
20	22	48
20	24	50
20	26	52
20	28	54
20	30	56
20	32	63
20	34	65
20	36	67
20	38	69
20	40	71
20	42	73
20	44	76
20	46	78
20	48	80

MODEL GRZ Weight Chart

H = Height of Section
W = Width of Section

Wt = Weight in Pounds per Linear Foot
 = Size not available

H	W	Wt
22	6	34
22	8	36
22	10	38
22	12	40
22	14	42
22	16	44
22	18	46
22	20	48
22	22	50
22	24	52
22	26	54
22	28	56
22	30	58
22	32	65
22	34	67
22	36	69
22	38	71
22	40	73
22	42	76
22	44	78
22	46	80
22	48	82

H	W	Wt
24	6	36
24	8	38
24	10	40
24	12	42
24	14	44
24	16	46
24	18	48
24	20	50
24	22	52
24	24	54
24	26	56
24	28	58
24	30	60
24	32	67
24	34	69
24	36	71
24	38	73
24	40	76
24	42	78
24	44	80
24	46	82
24	48	84

H	W	Wt
26	6	38
26	8	40
26	10	42
26	12	44
26	14	46
26	16	48
26	18	50
26	20	52
26	22	54
26	24	56
26	26	58
26	28	60
26	30	62
26	32	69
26	34	71
26	36	73
26	38	76
26	40	78
26	42	80
26	44	82
26	46	84
26	48	86

H	W	Wt
28	6	40
28	8	42
28	10	44
28	12	46
28	14	48
28	16	50
28	18	52
28	20	54
28	22	56
28	24	58
28	26	60
28	28	62
28	30	64
28	32	71
28	34	73
28	36	76
28	38	78
28	40	80
28	42	82
28	44	84
28	46	86

H	W	Wt
30	6	42
30	8	44
30	10	46
30	12	48
30	14	50
30	16	52
30	18	54
30	20	56
30	22	58
30	24	60
30	26	62
30	28	64
30	30	66
30	32	73
30	34	76
30	36	78
30	38	80
30	40	82
30	42	84
30	43	86

H	W	Wt
32	6	48
32	8	50
32	10	52
32	12	54
32	14	56
32	16	59
32	18	61
32	20	63
32	22	65
32	24	67
32	26	69
32	28	71
32	30	73
32	32	76
32	34	78
32	36	80
32	38	82
32	40	84

H	W	Wt
34	6	50
34	8	52
34	10	54
34	12	56
34	14	59
34	16	61
34	18	63
34	20	65
34	22	67
34	24	69
34	26	71
34	28	73
34	30	76
34	32	78
34	34	80
34	36	82
34	38	84

H	W	Wt
36	6	52
36	8	54
36	10	56
36	12	59
36	14	61
36	16	63
36	18	65
36	20	67
36	22	69
36	24	71
36	26	73
36	28	76
36	30	78
36	32	80
36	34	82
36	36	84

MODEL GRZ Weight Chart

P3

H = Height of Section
W = Width of Section

Wt = Weight in Pounds per Linear Foot
 = Size not available

H	W	Wt
38	8	56
38	10	59
38	12	61
38	14	63
38	16	65
38	18	67
38	20	69
38	22	71
38	24	73
38	26	76
38	28	78
38	30	80
38	32	82
38	34	84
Size not available		

H	W	Wt
40	8	59
40	10	61
40	12	63
40	14	65
40	16	67
40	18	69
40	20	71
40	22	73
40	24	76
40	26	78
40	28	80
40	30	82
40	32	84
Size not available		

H	W	Wt
42	8	61
42	10	63
42	12	65
42	14	67
42	16	69
42	18	71
42	20	73
42	22	76
42	24	78
42	26	80
42	28	82
42	30	84
Size not available		

H	W	Wt
44	8	63
44	10	65
44	12	67
44	14	69
44	16	71
44	18	73
44	20	76
44	22	78
44	24	80
44	26	82
44	28	84
44	29	85
Size not available		

H	W	Wt
46	8	65
46	10	67
46	12	69
46	14	71
46	16	73
46	18	76
46	20	78
46	22	80
46	24	82
46	26	84
46	28	86
Size not available		

H	W	Wt
48	8	67
48	10	69
48	12	71
48	14	73
48	16	76
48	18	78
48	20	80
48	22	82
48	24	84
48	26	86
48	27	87
Size not available		



1-888-VPSTACK (888-877-8225)

Phone 309-895-2311 • Fax 309-895-3891

302 Mill St. • Box 307 • Buda, Illinois 61314

Web site: www.vpstack.com

email: vptech@vpstack.com

© 2018 Van-Packer

Model GRZ Brochure 081121 #VP0070